



bernardi





# bernardi

There are significant gestures, recipes that are passed on from generation to generation, aromas and feelings we can never forget. The art of kneading is rooted way down in the past and forms common experience, which is part of our childhood memories and contributes to a collective cultural knowledge. Bread, pizza, focaccia, panettone and brioches: kneading demands technique, strength and determination. We save the natural character of gestures and allow kneading professionals to obtain the best results.

For 30 years the company BERNARDI from Cuneo has been specialized in the production of spiral, double arm and fork kneading machines. However, the kneading machines with double arms are its biggest strength since they have always represented the best technology for producing yeast dough (bread, pizza, focaccia, flaky pastry and panettone).

The beginning of the enterprise had been determined by the need of founder Elvio Bernardi to build a kneading machine capable of producing dough for domestic production of bread. It was during the first years of the 1980ies and there were only small spiral kneading machines available on the market. Benefitting from the experience made as a small boy working for a candy store, he knew however that there was no better than the double arm kneading machine to make good yeast dough. The pursuit of perfection made him construct a first small double arm kneading machine for himself that has been replicated after a short time, until it eventually became a profession.

Such a passion has been handed down to the second generation that keep their origins but have very clear goals in mind, keeping on developing this technology with ambitious plans.

# EXPERIENCE QUALITY AVANT-GARDE

## AN IMPORTANT CHOICE

The company has recently entered upon a complete reorganization either in respect to the production units and to the wide range of products among which the customers can choose.

The production process has been changed completely, now involving lean manufacturing concepts, so that to assure prompt deliveries and high standards in quality.

In order to be abreast with the times, important decisions have to be taken, which directly bring to a change.

## OUR MIND INTO THE FUTURE

Thanks to the adoption of the most recent "Smart Technology" systems, our company is ready to accept the challenges set forth by the fourth industrial revolution.



## MEETING OUR CUSTOMERS



WHITE ART  
TEST LAB



OPPORTUNITY  
EITHER FOR  
PROFESSIONALS  
AND  
ENTHUSIASTS



After 30 years of experience with the double arm technology BERNARDI enriched its own offer with a training project that is aimed at cooks and enthusiasts. In autumn 2013 the laboratory for the production of bread, pizza and candies opened and now everyone can deepen his knowledge of different kinds of dough and discover the potential of a technology that praises tradition.

Since the beginning BERNARDI has been trying to transfer the culture of the double arm technology, concerning both quality of the machines and excellent results that can be reached for all products of yeast dough.

The opening of BERNARDI BAKERY LAB composes the best opportunity to meet market needs and satisfy always more demanding customers, which is essential for a company that desires to keep up with time and therefore develops a suitable technology to reach best results.

# WHAT'S ON THE MARKET

## DOUBLE ARMS

Slow kneading system based on the movement of double arms that simulate manual work, which leads to a perfectly oxygenated dough. The reduced mechanical friction allows the dough not to be heated during the mixture, keeping the characteristics of the flour unchanged. Therefore, the double arms are optimal for every yeast dough.



## FORK

Kneading system based on the very slow rotation of a fork around an inclined axis, which enables an optimal oxygenation of dough without heating. Typically applied for dough of low hydration.

## SPIRAL

Fast kneading system based on the rotation of a spiral around its own axis, which causes an extension and stretch of the gluten network. This system creates strong friction that heats the dough, which requires certain adjustments like the usage of ingredients with low temperatures or an attentive time management during mixture.



# COMPACT KNEADING SYSTEM

## THE ADVANTAGES OF COMPACT KNEADING SYSTEM



COMPACT  
DIMENSIONS



OPTIMAL  
PRICE -  
PERFORMANCE  
RATIO



EXCELLENT  
RESULTS  
FOR BAKERS,  
PASTRY CHEFS  
AND PIZZA  
BAKERS

### COMPACT SYSTEM

The exclusive compact kneading arm system is a patent of Bernardi that allows the production of machines with compact dimensions and an optimal price-performance ratio.

The system adapts perfectly to the professional needs of bakers, pizza bakers and pastry chefs.

Our tests show that the compact system can even make the most difficult recipes such as large leavened kneading and high-hydration dough.

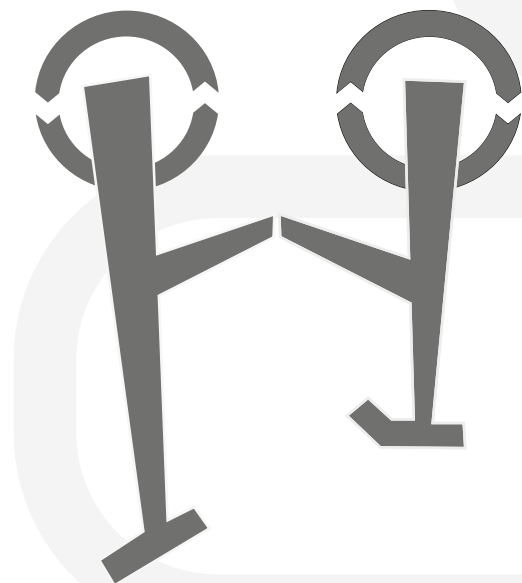

Bernardi patent

## KNEADING WITH THE DOUBLE ARM SYSTEM

The double arm system represents a kneading technique that puts flour in the center of the recipe. Flour is being put in the bowl at first and all other ingredients are proportioned according to the quantity of flour. Water is being added gradually and, if dough requires it, oil as well as other secondary ingredients are being added after dough is kneaded. Salt finishes the preparation after yeast has been kneaded homogeneously, which reduces losses of efficiency.



## STRINGING OF THE GLUTEN NETWORK

Gluten is a complex protein that develops due to the connection of two simple proteins – gliadin and glutenin. These are part of the flour, due to mechanical processes and the existence of water. That is why kneading is not a simple mixture of ingredients, but has the important function to string gluten networks that will help to support the dough during the rising.



# WHITE A WORLD OF



## TEMPERATURE OF DOUGH

Respecting the elements of nature is a fundamental rule of white art. While kneading, it is important to supervise the condition of the individual ingredients. The natural life force of yeast is being reduced dramatically by temperatures over 30 °C. The sugar contained in flour suffers from a caramelizing process, which changes its nature causing a smaller rise and affecting digestion badly. Thereby, the diverse friction caused by different kneading systems plays an important role.



## HYDRATION OF DOUGH

The amount of water is a fundamental element in the structure of dough and the organoleptic characteristics. A high hydration (more than 70% of water) provides dough a well-developed alveolation and favors its rise. Strongly hydrated dough requires however a correct choice of flour and an adequate preparation: the double arm system enables the transition of a strong mechanical energy, oxygenating dough perfectly without overheating it.

# ART YEAST & FLOUR



# CHOICE OF THE MODEL

DOUGH	RS	BTS
BREAD		
PIZZA		
EGG PASTA*		
SHORT PASTRY		
CROISSANTS		
PANETTONE		
HIGH IDRATATON DOUGH		

\* cutting the maximum kneading capacity by half

## RANGE

# rs

Kneading machine with two speed levels and the exclusive compact system with double arms – Bernardi's patent for professional use. The RS range is especially suitable for pizzerias and restaurant bread. The exclusive compact system enables the double arms to adapt to minimal space requirements and allows a good price-performance ratio.

The touch-system control board and the high efficiency induction engine permits to obtain a high torque with minimum consumption and a complete noiseless operation.

Easier emptying and cleaning operations thanks to its arms been completely extractible.



2 speed levels

RS	RS 12	RS 24	RS 48
Flour capacity	1,3 - 8 kg	2 - 15 kg	3 - 30 kg
Kneading capacity	2 - 12 kg	3 - 24 kg	5 - 48 kg
Bowl capacity	27 lt	35 lt	60 lt
Dimensions of bowl	Ø 38 - h 25	Ø 43 - h 30	Ø 50 - h 34
Voltage	230 V single-phase	230 V single-phase	230 V single-phase
Power	1100 W	1500 W	1500 W
Speed of the arms	38 e 52 strokes/min	38 e 52 strokes/min	38 e 52 strokes/min
Dimensions LxPxH (cm)	41x69x86	45x71x91	53x77x96
Weight	80 kg	98 kg	121 kg
Code	RS1223029	RS2423029	RS4823029
Price	--	--	--

### FAQ

**EXTRACTIBLE ARMS:** : its arms being completely extractible makes emptying and cleaning operations easier.

**USERS:** perfect for pizzerias and restaurants.

RS Range  
Kneading machine with two speed levels  
and compact double arm system

USERS  
Pizzerias and restaurants

USE  
Suitable for basic dough for pizzas, bread and focaccia

MAIN CHARACTERISTICS  
Two-speed arm moving system (38 and 52 strokes per minute)  
Small-sized double-arm compact system  
Completely extractible kneading arms  
Double-channel emergency stop system ("Safety Torque Off")  
Touch-system control board  
High efficiency induction engine

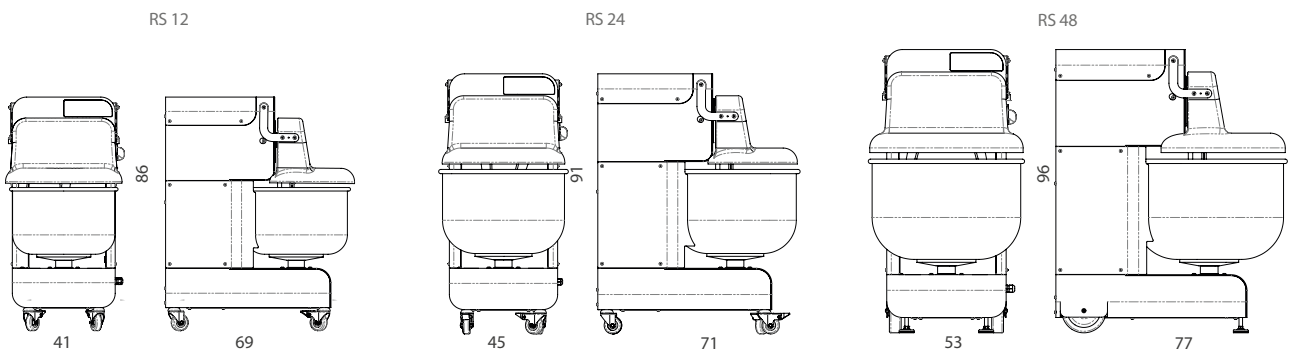

WEIGHT and  
VOLUMES

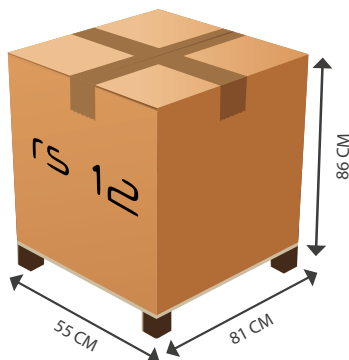

95  
KG

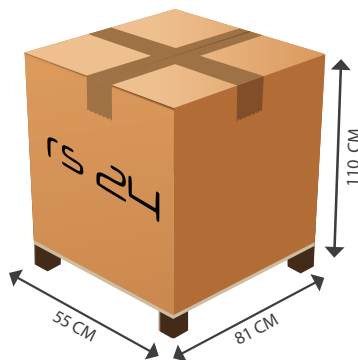

113  
KG

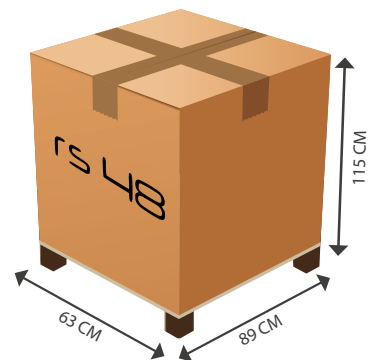

136  
KG

RANGE

bt<sub>s</sub>

The BTs range represents the top of the double arm mixer range with the same kneading capacity and spacial dimensions of RS, but with an advanced five-speed inverter-controlled arm moving system to vary speed from 25 to 65 strokes per minute for every kind of doughs.

The compact double arm system – Bernardi's patent for professional usage allows the integration of the advantages of the double arm system with minimal space requirements and an optimal price-performance ratio.

The touch-system control board and the high efficiency induction engine permits to obtain a high torque with minimum consumption and a complete noiseless operation.

Easier emptying and cleaning operations thanks to its arms been completely extractible.



5 speed levels

BTs	BT 12s	BT 24s	BT 48s	BT 60s
Flour capacity	1,3 - 8 kg	2 - 15 kg	3 - 30 kg	3 - 35 kg
Kneading capacity	2 - 12 kg	3 - 24 kg	5 - 48 kg	5,5 - 60 kg
Bowl capacity	27 lt	35 lt	60 lt	85 lt
Dimensions of bowl	Ø 38 - h 25	Ø 43 - h 30	Ø 50 - h 34	Ø 55 - h 36
Voltage*	400 V three-phase	400 V three-phase	400 V three-phase	400 V three-phase
Power	1100 W	1500 W	1500 W	2500 W
Speed of the arms	from 25 to 65 strokes/min	da 25 a 65 strokes/min	da 25 a 65 strokes/min	da 25 a 65 strokes/min
Dimensions LxPxH (cm)	41x69x86	45x71x91	53x77x96	58x86x107
Weight	100 kg	120 kg	140 kg	243 kg
Code	BT1240059	BT2440059	BT4840059	BT6040059
Price	--	--	--	--

\*UPON REQUEST: 230 V single phase.

#### FAQ

**EXTRACTIBLE ARMS:** : its arms being completely extractible makes emptying and cleaning operations easier.

**USERS:** perfect for pizzerias, restaurants and pastry making shops.

BTs Range  
Kneading machine with five speed levels  
and compact double arm system

USERS  
Bakeries and pastry making shops

USE  
Suitable for basic dough for pizzas, bread, focaccia,  
high hydration doughs and large leavened kneading

MAIN CHARACTERISTICS  
Five-speed inverter-controlled arm moving system (from 25 to 65 strokes per minute)  
Small-sized double-arm compact system  
Completely extractible kneading arms  
Double-channel emergency stop system ("Safety Torque Off")  
Touch-system control board  
High efficiency induction engine  
Bluetooth communication system to use proprietary application "MixDrive" on iOS and  
Android smartphones

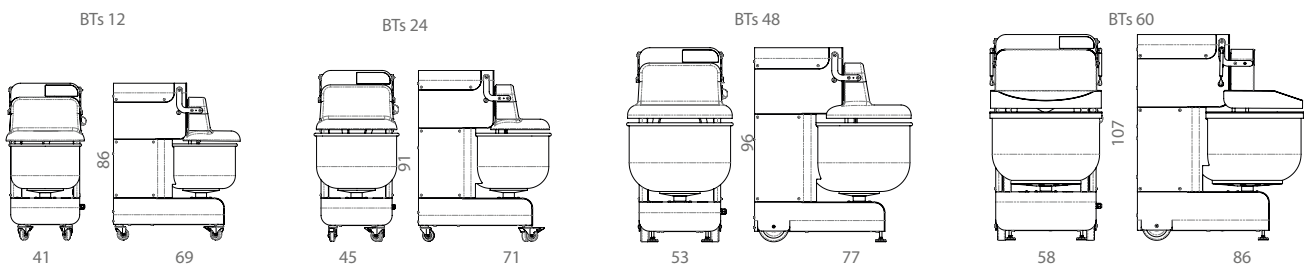

## WEIGHT and VOLUMES

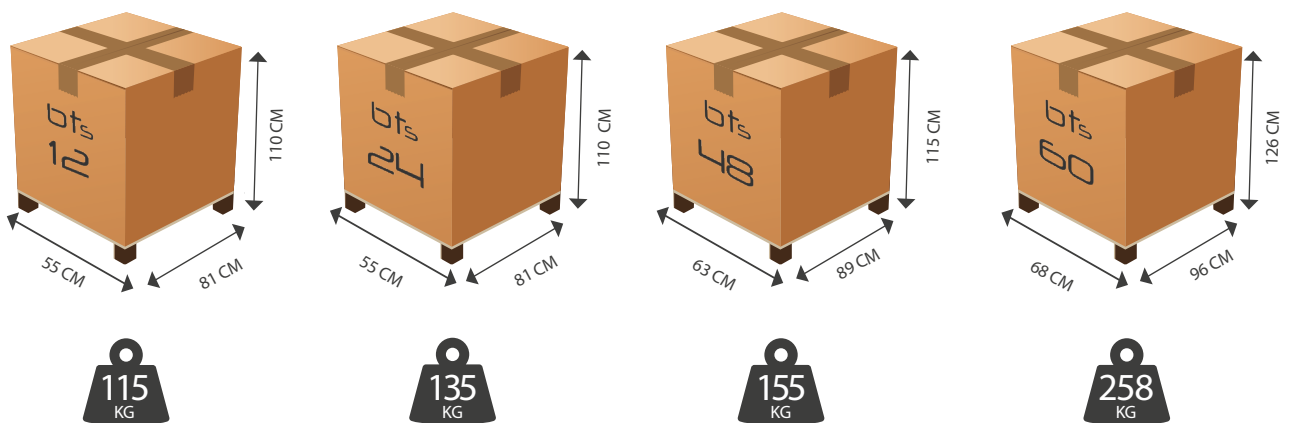

Bernardi srl  
Via Caduti sul Don, 1  
12020 Villar San Costanzo – CN  
Tel. 0171 902352  
Fax 0171 902280  
[info@bernardi-impastatrici.it](mailto:info@bernardi-impastatrici.it)  
[www.bernardi-impastatrici.it](http://www.bernardi-impastatrici.it)  
[www.missbaker.it](http://www.missbaker.it)

Bernardi Bakery Lab  
Via della Magnina, 3/b  
12100 Cuneo – CN  
[info@bernardibakerylab.it](mailto:info@bernardibakerylab.it)

Authorized dealer