



PIZZA OVENS



UNISTARA. BRING WARMTH TO YOUR TABLE.





An ancient land.

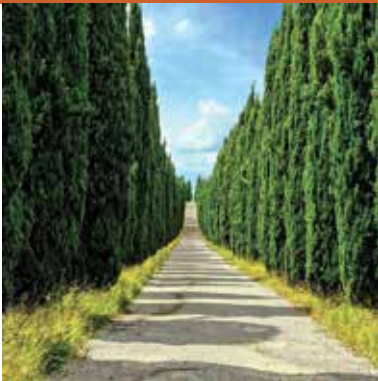

Tuscany, a land rich with art and culture.

Renowned all over the world for its enchanted landscapes and cities suspended in time, for its refined wines and its tasty and traditional cuisine. All this is the result of **an ancient artisan knowledge**, that in these locations kept itself intact during centuries and reaches to us as always original and surprising.

Unistara pizza ovens were born from this tradition, **hand made** - one by one - in the heart of Tuscany.

The **Ovens Line** includes **20 models** of wood-burning ovens to enjoy pizzas, focaccia and farinata, but also to rediscover the pleasure of wood-burning Italian traditional cooking.

The new process of manual processing and the choice of refractory mix enhance the craft irregularities in shape and improve the compactness of the vault (roof) by preventing the formation of cracks and air bubbles. Authentic and genuine flavours lost in time can arise only from artisan passion.





An ancient knowledge.





Home Line

"Linea Casa" ovens are thought to satisfy the needs of small and large families. They are made using only natural refractory products.

Cooking surface is made by 4 or 6 slabs refractory material having high heat storage; the dome is made by 2 or more snap fit elements making the cooking chamber. The shape of the dome enables food to cook in an even flame and enriches them with the flavour of wood stove cooking. There are 4 models available: ø80 cm, ø100 cm, ø110 cm or with elliptical shape 110x140 cm.

They are supplied together with metal sheet door with temperature gauge.

The version with larger opening, mainly used in Liguria for the making of farinata, enables the introductions of bigger baking trays.

Insulation kit, arch and chimney pipe connector are sold separately.



Detail of larger opening version

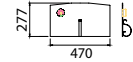
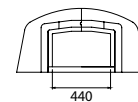
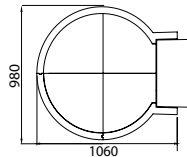
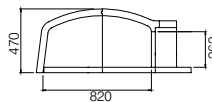

Model	Description	External dimensions	Opening dimensions	Internal dimensions	Number of pizzas	(h) Wood consumption	Heating time	Weight	Room available	Ø uscita furni
LC80	Home Line oven ø80 cm	98x106	44x26	82	2/3	3/4 kg	30	210	135x135	20
LC80BL	Home Line oven ø80 cm large opening	98x106	56x26	82	2/3	3/4 kg	30	210	135x135	20

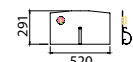
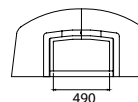
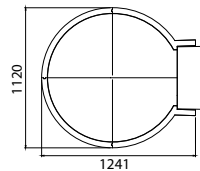
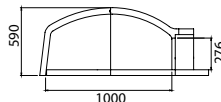

Model	Description	External dimensions	Opening dimensions	Internal dimensions	Number of pizzas	(h) Wood consumption	Heating time	Weight	Room available	Ø chimney pipe
LC100	Home Line oven ø100 cm	112x124	49x27	100	4/5	4/5 kg	35	360	150x155	20
LC100BL	Home Line oven ø100 cm large opening	112x124	68x27	100	4/5	4/5 kg	35	360	150x155	20

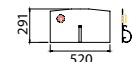
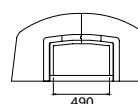
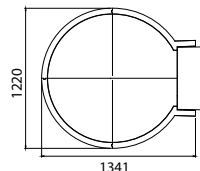
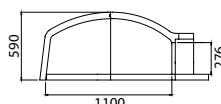

Model	Description	External dimensions	Opening dimensions	Internal dimensions	Number of pizzas	(h) Wood consumption	Heating time	Weight	Room available	Ø chimney pipe
LC110	Home Line oven ø110 cm	122x134	49x27	110	5/6	5 kg	40	370	160x165	20
LC100BL	Home Line oven ø110 cm large opening	122x134	68x27	110	5/6	5 kg	40	370	160x165	20

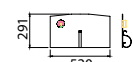
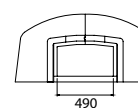
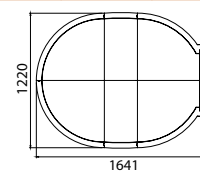
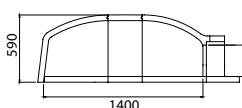

Model	Description	External dimensions	Opening dimensions	Internal dimensions	Number of pizzas	(h) Wood consumption	Heating time	Weight	Room available	Ø chimney pipe
LC110	Home Line oven 110x140 cm	122x164	49x27	114x140	7/8	6/7 kg	60	460	180x200	20
LC100BL	Home Line oven 110x140 cm large opening	122x164	68x27	114x140	7/8	6/7 kg	60	460	180x200	20

Dimensions and number of pizzas are indicative



Semi Pro Line



Semi Pro Line ovens are designed for the lovers of wood stove cooking. They are suitable for a semi-professional use and they will be the joy of the enthusiasts of wood stove cooking and all people that don't want to renounce to traditional cooking. As the "Linea Casa" models cooking surface is made by 4 or 6 slabs refractory material having high heat storage; the dome is made

by 2 or more snap fit elements making the cooking chamber. They are available in 4 models: $\varnothing 80$ cm, $\varnothing 100$, $\varnothing 110$ cm, with elliptical shape 110x140 cm, with two levels. **They are supplied together with metal sheet door with temperature gauge.** Semi Pro Line as well as "Linea Casa" has the possibility of a larger opening. **Insulation kit, arch and chimney pipe connector are sold separately.**

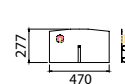
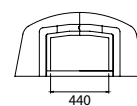
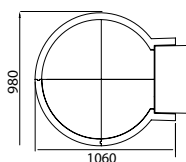
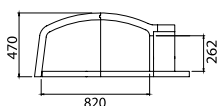

Model	Description	External dimensions	Opening dimensions	Internal dimensions	Number of pizzas	(h) Wood consumption	Heating time	Weight	Room available	\varnothing chimney pipe
LC80	Semi Pro Line oven $\varnothing 80$ cm	98x106	44x26	82	2/3	3/4 kg	30	210	135x135	20
LC80BL	Semi Pro Line oven $\varnothing 80$ cm large opening	98x106	56x26	82	2/3	3/4 kg	30	210	135x135	20

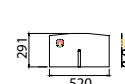
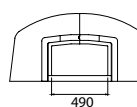
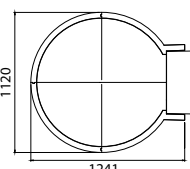
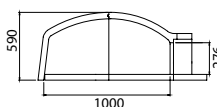

Model	Description	External dimensions	Opening dimensions	Internal dimensions	Number of pizzas	(h) Wood consumption	Heating time	Weight	Room available	\varnothing chimney pipe
LSP100	Semi Pro Line oven $\varnothing 100$ cm	112x124	49x27	100	4/5	4/5 kg	35	360	150x155	20
LSP100BL	Semi Pro Line oven $\varnothing 100$ cm large opening	112x124	68x27	100	4/5	4/5 kg	35	360	150x155	20

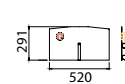
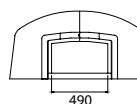
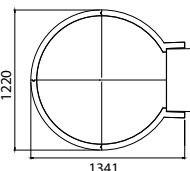
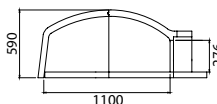

Model	Description	External dimensions	Opening dimensions	Internal dimensions	Number of pizzas	(h) Wood consumption	Heating time	Weight	Room available	\varnothing chimney pipe
LSP110	Semi Pro Line oven $\varnothing 110$ cm	122x134	49x27	110	5/6	5 kg	45	370	160x165	20
LSP110BL	Semi Pro Line oven $\varnothing 110$ cm large opening	122x134	68x27	110	5/6	5 kg	45	370	160x165	20

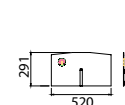
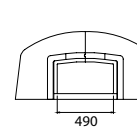
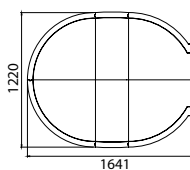
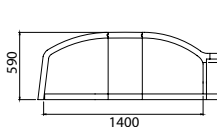

Model	Description	External dimensions	Opening dimensions	Internal dimensions	Number of pizzas	(h) Wood consumption	Heating time	Weight	Room available	\varnothing chimney pipe
LSP110140	Semi Pro Line oven 110x140 cm	122x164	49x27	114x140	7/8	6/7 kg	70	460	180x200	20
LSP110140BL	Semi Pro Line oven 110x140 cm large opening	122x164	68x27	114x140	7/8	6/7 kg	60	460	180x200	20



Professional Line

Professional Line ovens are available in two dimensions: round version diameter 140 cm and the elliptical one 140x170 cm. They combine the appeal of the artisan production with the needs of great pizza restaurants. Their strong point is their simplicity. Cooking surface is made by 6 or 10 slabs refractory material having high heat storage; the dome is made by 6 or 10 snap fit elements making the cooking chamber.

Thanks to the high storage heating capacity and the insulation kit, Professional Line ovens maintain their temperature for a long time without dispersing it and cook in an even way in all the areas of the oven. **This is why they can guarantee, for many years, extreme performances and rhythms. They are supplied together with metal sheet door with temperature gauge, insulation kit, arch and chimney pipe connector.**

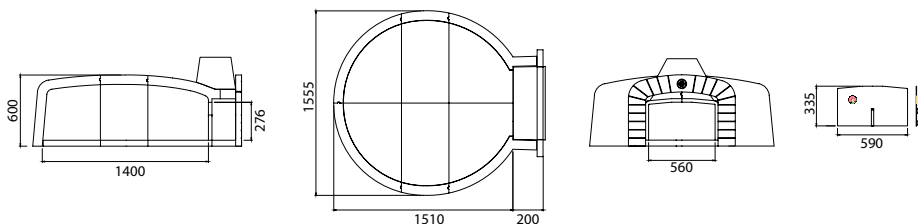

		External dimensions	Opening dimensions	Internal dimensions	Number of pizzas	(h) Wood consumption	Heating time	Weight	Room available	Ø chimney pipe
LP140	Linea Pro oven Ø140 cm	171x155	56x27	Ø140	8/9	7 kg	60	800	200x200	20
LP140BL	Linea Pro oven Ø140 cm large opening	171x155	68x27	Ø140	8/9	7 kg	60	800	200x200	20

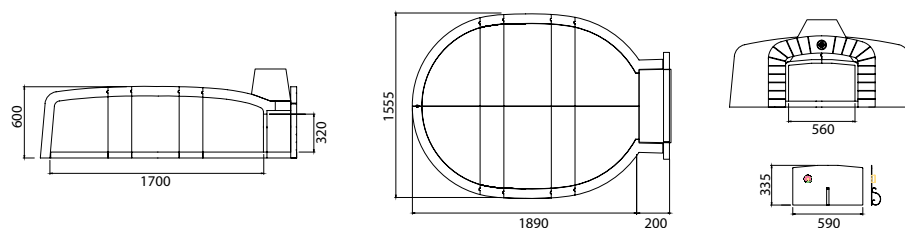

		External dimensions	Opening dimensions	Internal dimensions	Number of pizzas	(h) Wood consumption	Heating time	Weight	Room available	Ø chimney pipe
LP140	Linea Pro oven 140x170 cm	209x155	56x27	140x170	12/13	8 kg	70	900	230x200	20
LP140BL	Linea Pro oven 140x170 cm large opening	209x155	68x27	140x170	12/13	8 kg	70	900	230x200	20





Spare parts, accessories, insulation kit

All pizza oven are supplied together with metal sheet door with temperature gauge. The new palletizing system, besides simplifying storage, increases the protection against accidental bumps and shocks during handling.

Professional Line are supplied with arch and chimney pipe connector. Arch and chimney pipe connector are sold separately in **Home Line** and **Semi Pro Line** pizza ovens.

Pizza peel set (three different sets), the metal sheet door, the temperature gauge and the single elements for the base or the dome of the oven can be bought separately.

Insulating kit

Insulating kit comprises all the essential products for an optimal assembly of the oven and it includes the insulating blocks to place the base of the oven, the mortar to seal the joints of the dome, the insulating mat in biosoluble fiber and vermiculite for insulation.

Oven dimensions	Home Line - Semi Pro Line				Professional Line	
	Ø80	Ø100	Ø110	110x140	Ø140	140x170
Insulating blocks	n° 12	14	14	18	24	32
Ecological fiber insulation rolls	n° 1	1	1	2	3	3
Refractory mortar Refraset	kg 10	10	10	20		
Refractory mortar Unibond A25	kg				50	50
Vermiculite granular in sacks	n° 6	8	8	10	13	16



Simple assembly

On the carpentry for the assembly of the oven, build a brick kerb and put, in the middle, dry, the insulating blocks you will find in the insulating kit. Still in dry form, install the cooking surface elements lining them in the centre and build the dome. Seal, only externally all the joints between the elements composing the dome, with the mortar included in the kit and glue the chimney pipe connector and the arch.

Cover all the dome with the insulating blanket included in the kit and connect the chimney pipe to the chimney pipe connector. Build the closing walls of the oven thinking of, if necessary, aeration lateral grids and fill the empty spaces between oven and external walls with supplied granulated vermiculite before building the protection roof (for more detailed infos, check our website www.unistara.it).

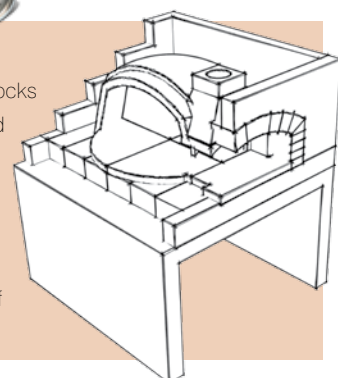



For more informations:

lineaforni@unistara.com

Tel: +39 010 57 699

Fax: +39 010 59 19 49

www.unistaraforni.it



UNISTARA S.p.A. - High Quality Refractories

Milano • Torino • Brescia • Padova • Genova

Modena • Firenze • Napoli

Head Office:

Piazza Rossetti, 3 • I-16129 Genova GE • ITALY

www.unistara.com